

Honda Racing Line

Decal Schematic

(For use with decals supplied in racer kit.)

Layout Specifications:

Helmet Visor - The Honda decal for the helmet visor is optional.

Rear Quarter Panels – Place 15" Honda Racing/HPD decals on right and left side rear quarter panels. Align the end of the decals with the corner of the back tail light, with approximately 1" gap between the tail light and the sticker's edge.

Windshield Visor - Place 52"X12" black windshield banner with 29.5" Honda logo printed in white on the upper portion of the windshield, centering the white print with the middle of the windshield horizontally. Adjust the banner's vertical top length according to your car model's windshield. Trim off all excess material.

Helmet Visor (Optional)



Color Specifications:

For light colored cars, all rear quarter panel decals should have red Honda Racing with black HPD banner.

For dark colored cars, all rear quarter panel decals should have red Honda Racing with white HPD banner.

Rear Quarter Panels

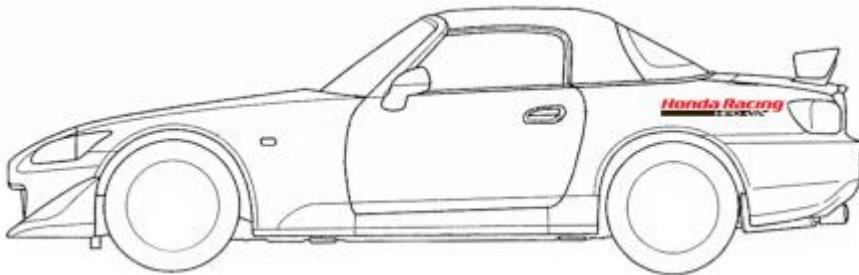

Light Colored Cars:

Dark Colored Cars:

Windshield Visor

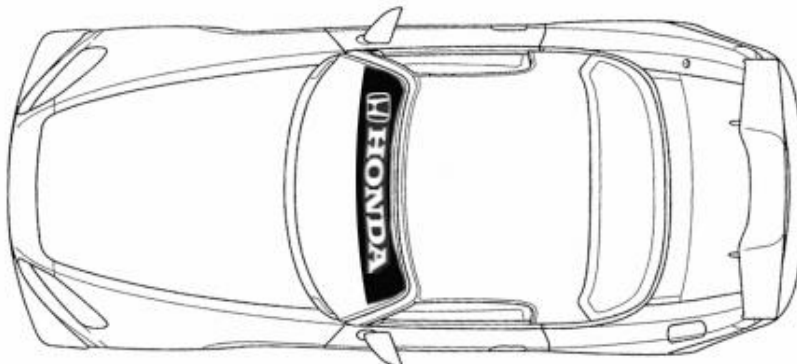

To reorder decals, please call or email: (661) 702-7777 / grmsadmin@hra.com

ACURA Decal Schematic

(For use with decals supplied in racer kit.)

Layout Specifications:

Helmet Visor - The Acura decal for the helmet visor is optional.

Rear Quarter Panels – Place 15" Acura Motorsports decals on right and left side rear quarter panels. Align the end of the decals with the corner of the back tail light, with approximately 1" gap between the tail light and the sticker's edge.

Windshield Visor - Place 52"X12" blue windshield banner with 27.5" Acura logo printed in silver on the upper portion of the windshield, centering the silver print with the middle of the windshield horizontally. Adjust the banner's vertical top length according to your car model's windshield. Trim off all excess material.

Helmet Visor (Optional)



Color Specifications:

For light colored cars, all rear quarter panel decals should have the Acura in blue and Motorsports in silver.

For dark colored cars, all rear quarter panel decals should be entirely in silver.

Rear Quarter Panels

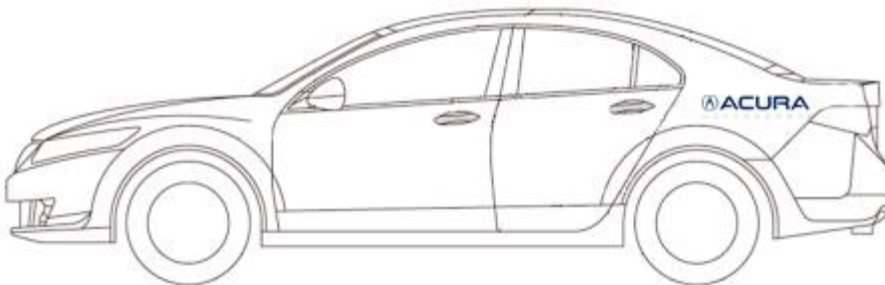

Light Colored Cars:



Dark Colored Cars:



Windshield Visor

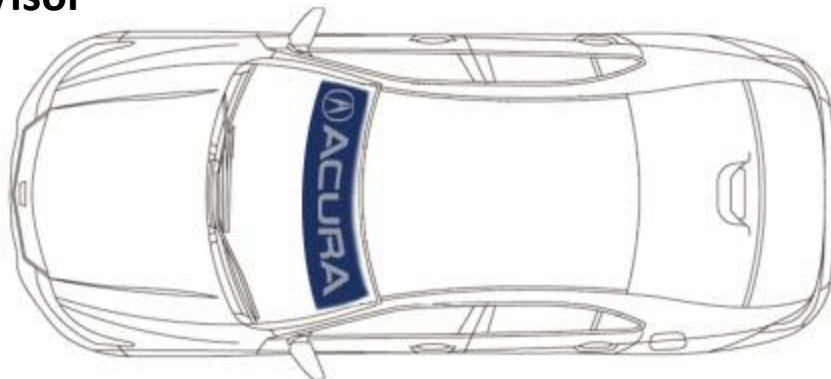

To reorder decals, please call or email: (661) 702-7777 / grmsadmin@hra.com

Honda Racing Line – Honda Performance Development, Inc.

Honda Racing Line

Fit Decal Schematic

(For use with decals supplied in racer kit.)

Layout Specifications:

Helmet Visor - The Honda decal for the helmet visor is optional.

Nose - Place 3" "H" mark decal, centering the middle of the "H" mark with the center of the car nose. Please allow enough space around the entire decal to equal $\frac{1}{2}$ the height of the "H" mark in all directions.

Engine Cover - Place 15" Honda decals on right and left side of the engine cover, approximately 1" from the top and centered between the edges of the highest point. The decal placement for those chassis without a large intake scoop will vary.

Helmet Visor (Optional)



Color Specifications:

For light colored cars, all decals should have red Honda Racing with black HPD banner and black Honda logos.

For dark colored cars, decals should have red Honda Racing with white HPD banner and white Honda logos.

Nose

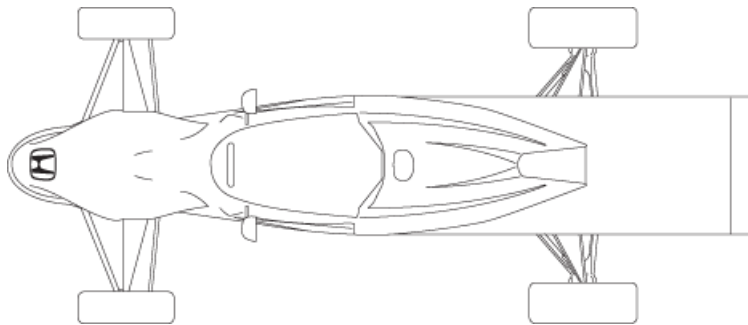

Light Colored Cars:

HONDA



Dark Colored Cars:

HONDA



Engine Cover

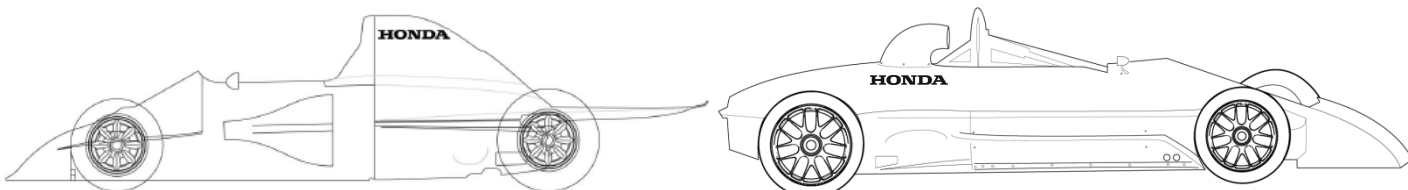

To reorder decals, please call or email: (661) 702-7777 / grmsadmin@hra.com

Honda Racing Line

Kart Decal Schematic

(For use with decals supplied in racer kit.)

Layout Specifications:

Helmet Visor - The Honda decal for the helmet visor is optional.

Front Fairing- Place 3.5" "H" mark decal, centering the middle of the "H" mark with the horizontal center of the front fairing.

Nose - Place 9" Honda Racing/HPD decal at the center of the nose on the kart. The space between the two decals should be no less than ½ the height of the "H" mark decal.

Helmet Visor (Optional)



Decals:



Nose & Front Fairing

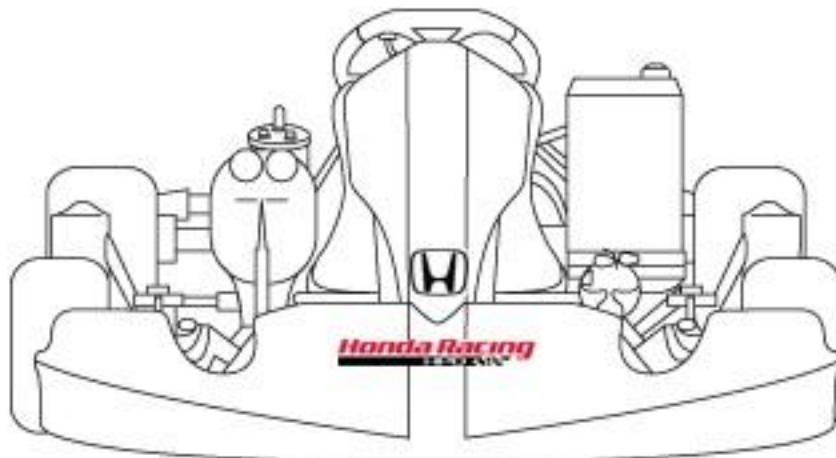

To reorder decals, please call or email: (661) 702-7777 / grmsadmin@hra.com

Honda Racing Line

Quarter Midget Decal Schematic

(For use with decals supplied in racer kit.)

Layout Specifications:

Helmet Visor - The Honda decal for the helmet visor is optional.

Front Fairing- Place 3.5" "H" mark decal, centering the middle of the "H" mark with the horizontal center of the front fairing.

Engine Cover & Side Panel- Place 9" Honda decals on right and left side of the engine cover and/or side panel, approximately 2" from the top and centered between the edges of the highest point. The decal placement will slightly vary depending on chassis type.

Helmet Visor (Optional)



Decals:

Honda Racing
HPD



Front Fairing & Engine Cover

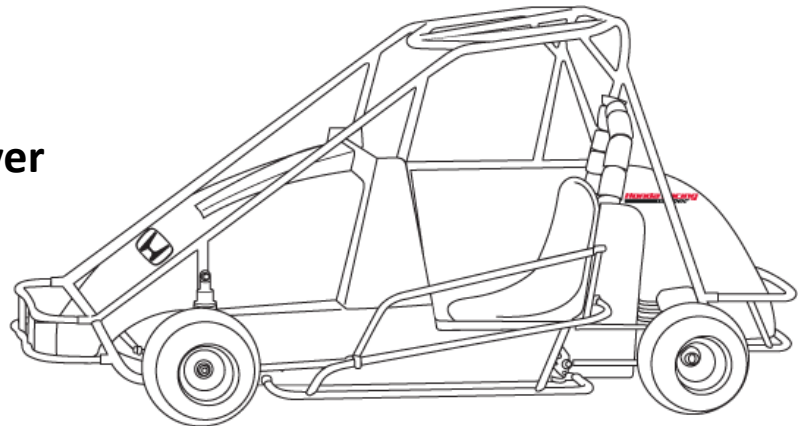

Side Panel

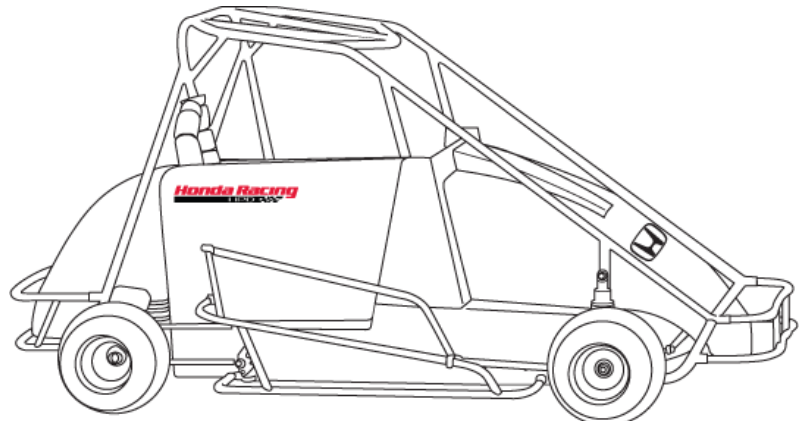

To reorder decals, please call or email: (661) 702-7777 / grmsadmin@hra.com